



INSTYTUT TECHNIKI BUDOWLANEJ
PL 00-611 WARSZAWA
ul. Filtrowa 1
tel.: (+48 22) 825-04-71
(+48 22) 825-76-55
fax: (+48 22) 825-52-86
www.itb.pl



Member of



www.eota.eu

European Technical Assessment

**ETA-10/0392
of 30/06/2020**

General Part

Technical Assessment Body issuing the European Technical Assessment

Instytut Techniki Budowlanej

Trade name of the construction product

SMART® LBP and SMART® BP multifunctional anchors
SMART® RP, RPT, RPZ, RPF and RPC frame anchors

Product family to which the construction product belongs

Plastic anchors for multiple use in concrete and masonry for non-structural applications

Manufacturer

pgb – Polska Sp. z o.o.
ul. F.W.Redena 3
PL 41-807 Zabrze, Poland

Manufacturing plant

pgb – Polska Sp. z o.o.
ul. F.W.Redena 3
PL 41-807 Zabrze, Poland

This European Technical Assessment contains

25 pages including 3 Annexes which form an integral part of this Assessment

This European Technical Assessment is issued in accordance with regulation (EU) No 305/2011, on the basis of

Guideline for European Technical Approval of "Plastic anchors for multiple use in concrete and masonry for non-structural applications", ETAG 020, Edition March 2012 used as European Assessment Document

This version replaces

ETA-10/0392 issued on 29/06/2017

This European Technical Assessment is issued by the Technical Assessment Body in its official language. Translations of this European Technical Assessment in other languages shall fully correspond to the original issued document and shall be identified as such.

Communication of this European Technical Assessment, including transmission by electronic means, shall be in full. However, partial reproduction may only be made with the written consent of the issuing Technical Assessment Body. Any partial reproduction has to be identified as such.

Specific Part

1 Technical description of the product

The multifunctional anchors SMART® LBP and SMART® BP (SMART® LBP ϕ 8, SMART® LBP ϕ 10, SMART® BP ϕ 12, SMART® BP ϕ 14) and frame anchors SMART® RP ϕ 10, SMART® RPT ϕ 10, SMART® RPZ ϕ 10, SMART® RPF ϕ 10 with countersunk plug and SMART® RPC ϕ 10 with cylindrical collar are the plastic anchors consisting of a plastic sleeve made of polyamide and an accompanying specific screw made of galvanised or stainless steel.

The plastic sleeve is expanded by screwing in the specific screw which presses the sleeve against the wall of the drilled hole.

The description of the product are given in Annex A.

2 Specification of the intended use in accordance with the applicable European Assessment Document (EAD)

The performance given in Annex C are only valid if the anchor is used in compliance with the specifications and conditions given in Annex B.

The provisions made in this European Technical Assessment are based on an assumed working life of the anchor of 50 years. The indications given on the working life cannot be interpreted as a guarantee given by the producer or Technical Assessment Body, but are to be regarded only as a means for choosing the right products in relation to the expected economically reasonable working life of the works.

3 Performance of the product and references to the methods used for its assessment

3.1 Performance of the product

3.1.1 Mechanical resistance and stability (BWR 1)

Requirements with respect to the mechanical resistance and stability of non load bearing parts of the works are not included in this Basic Requirement but are under the Basic Requirement safety in use (BWR 4).

3.1.2 Safety in case of fire (BWR 2)

3.1.2.1 Reaction to fire

The metal parts of plastic anchors can be classified to class A1 reaction to fire in accordance with the provisions of EC Decision 96/603/EC (as amended).

In the context of the end use application of the anchorages the plastic material of the anchor embedded in concrete/masonry can be considered to satisfy any reaction to fire requirements. Where the plastic parts of the anchor are embedded in the cladding/component which is not class A1 reaction to fire the plastic parts can be considered not to influence the reaction to fire class of the cladding/component.

3.1.2.2 Resistance to fire

No performance assessed.

3.1.3 Hygiene, health and the environment (BWR 3)

No performance assessed.

3.1.4 Safety in use (BWR 4)

Essential characteristic	Performance
Characteristic resistance for tension and shear loads	Annex C1, C2, C3
Characteristic resistance for bending moment	Annex C1
Displacements under shear and tension loads	Annex C2, C4
Edge distances and spacings	Annex B3, B4

3.1.5 Sustainable use of natural resources (BWR 7)

No performance assessed.

3.1.6 General aspects relating to fitness for use

Durability and serviceability are only ensured if the specifications of intended use according to Annex B are kept.

3.2 Methods used for the assessment

The assessment of the anchors has been made in accordance with the ETAG 020 "Plastic anchors for multiple use in concrete and masonry for non-structural applications".

4 Assessment and verification of constancy of performance (AVCP) system applied, with reference to its legal base

According to the Decision 97/463/EC of the European Commission the system 2+ of assessment and verification of constancy of performance (see Annex V to Regulation (EU) No 305/2011) applies.

5 Technical details necessary for the implementation of the AVCP system, as provided in the applicable European Assessment Document (EAD)

Technical details necessary for the implementation of the AVCP system are laid down in the control plan deposited in Instytut Techniki Budowlanej.

For the type testing the results of the tests performed as part of the assessment for the European Technical Assessment shall be used unless there are changes in the production line or plant. In such cases the necessary type testing has to be agreed between Instytut Techniki Budowlanej and the notified body.

Issued in Warsaw on 30/06/2020 by Instytut Techniki Budowlanej

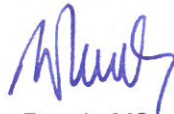

Anna Panek, MSc
Deputy Director of ITB

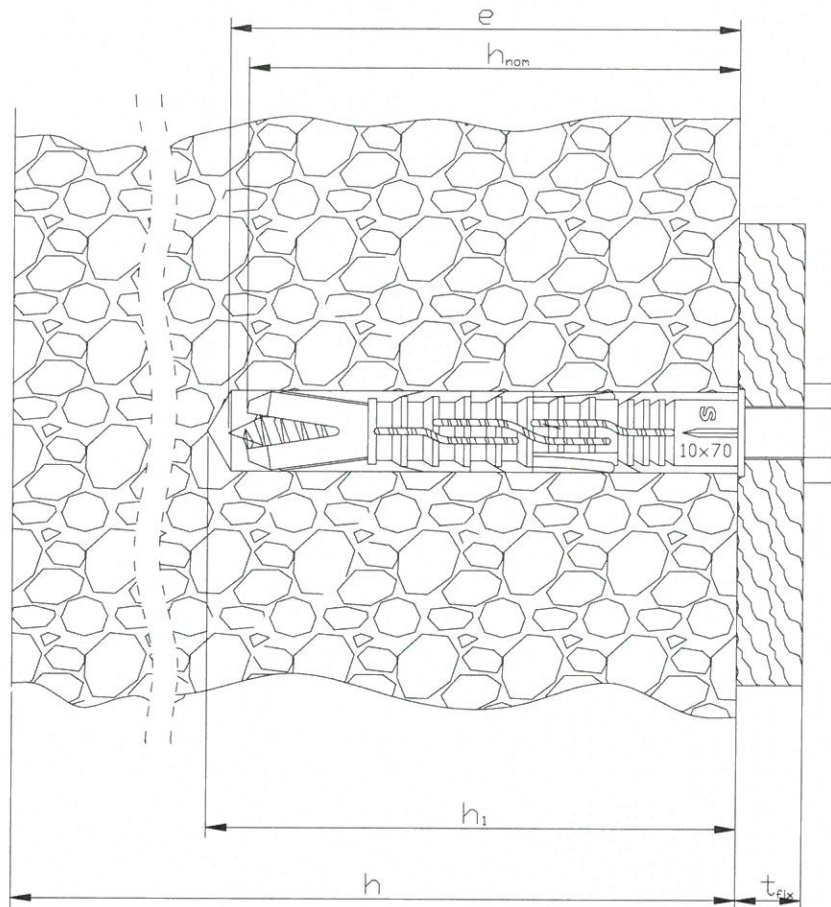

Intended Use

Fixing in concrete and masonry

Legend

- h_{nom} = overall plastic anchor embedment depth in the base material
- e = screw length in the base material
- h_1 = depth of drill hole to deepest point
- h = thickness of member (wall)
- t_{fix} = thickness of fixture

**SMART® LBP and SMART® BP multifunctional anchors
SMART® RP, RPT, RPZ, RPF and RPC frame anchors**

Product description
Intended use – SMART® LBP or SMART® BP
multifunctional anchor

Annex A1
of European
Technical Assessment
ETA-10/0392

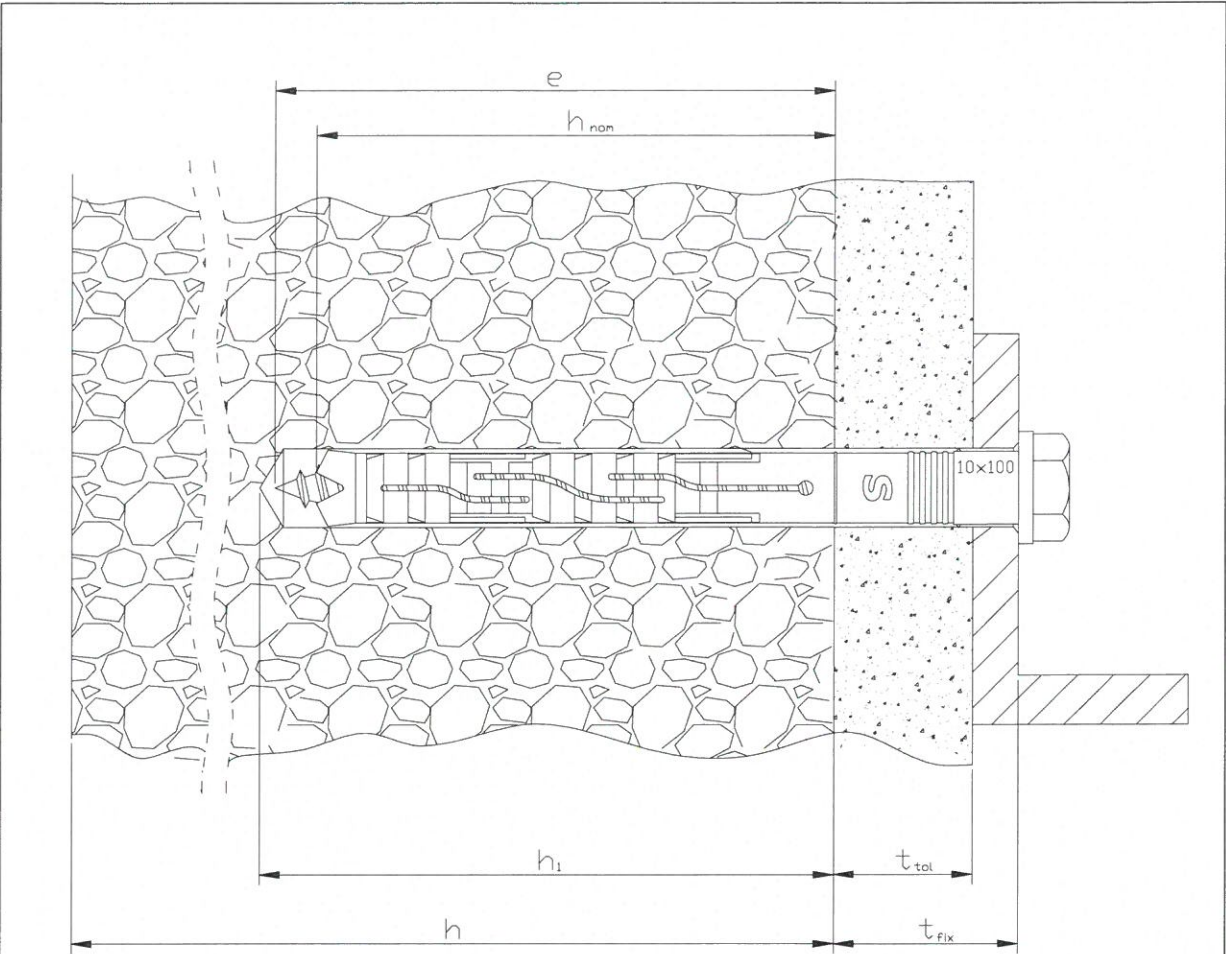

Intended Use

Fixing in concrete and masonry

Legend

- h_{nom} = overall plastic anchor embedment depth in the base material
- e = screw length in the base material
- h_1 = depth of drill hole to deepest point
- h = thickness of member (wall)
- t_{fix} = t_{tol} + thickness of fixture
- t_{tol} = thickness of layer or non-load-bearing coating

<p>SMART® LBP and SMART® BP multifunctional anchors SMART® RP, RPT, RPZ, RPF and RPC frame anchors</p>	<p>Annex A2 of European Technical Assessment ETA-10/0392</p>
<p>Product description Intended use – SMART® RPC frame anchors</p>	

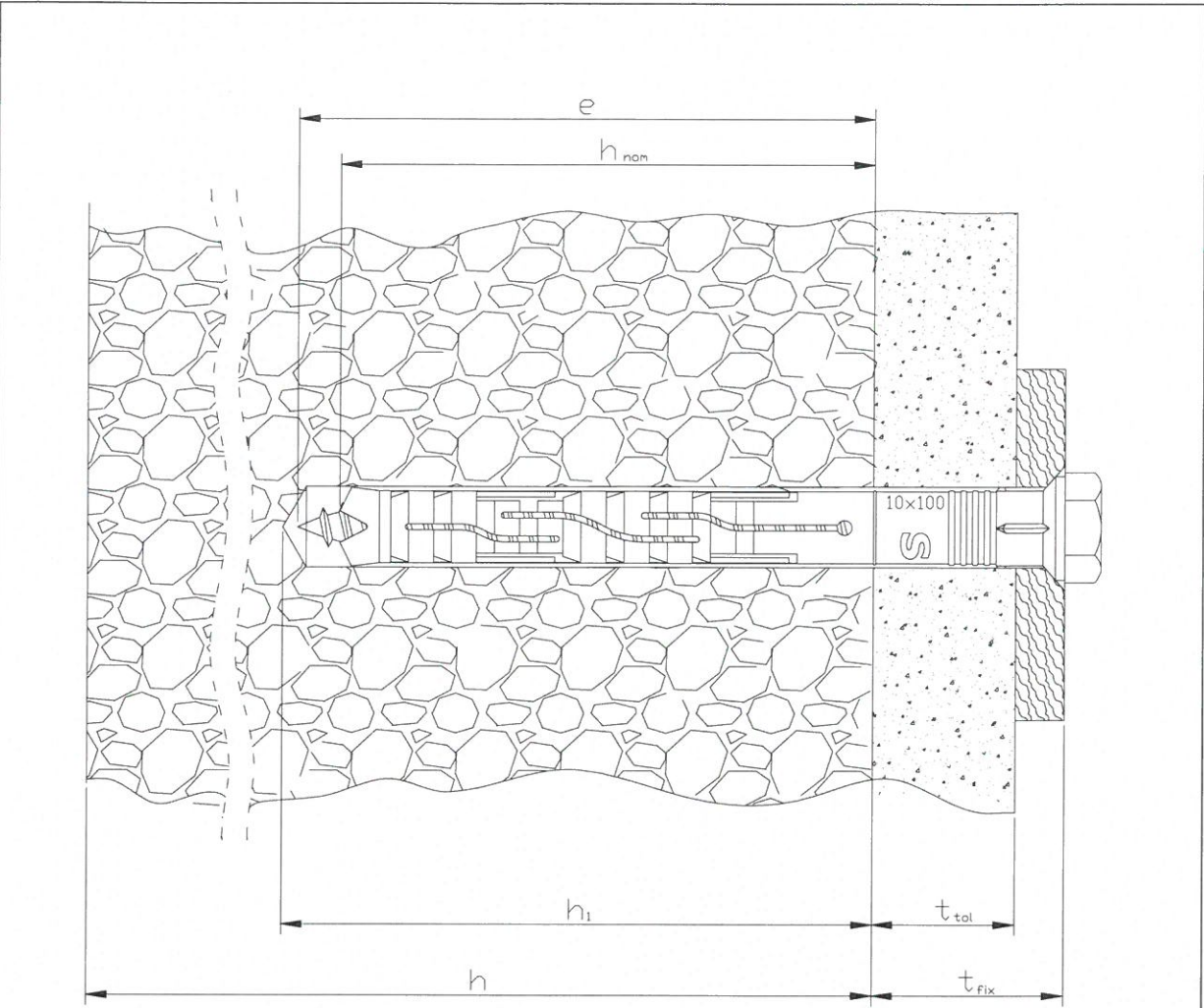

Intended Use

Fixing in concrete and masonry

Legend

- h_{nom} = overall plastic anchor embedment depth in the base material
- e = screw length in the base material
- h_1 = depth of drill hole to deepest point
- h = thickness of member (wall)
- t_{fix} = t_{tol} + thickness of fixture
- t_{tol} = thickness of layer or non-load-bearing coating

<p>SMART® LBP and SMART® BP multifunctional anchors SMART® RP, RPT, RPZ, RPF and RPC frame anchors</p>	<p>Annex A3 of European Technical Assessment ETA-10/0392</p>
<p>Product description Intended use – SMART® RP, RPT, RPZ, RPF frame anchors</p>	

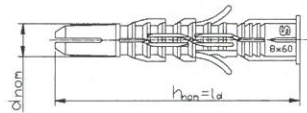

SMART® LBPφ8

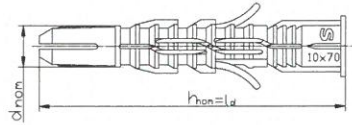

SMART® LBPφ10

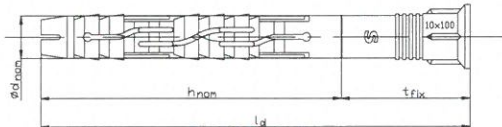

SMART® RPφ10

SMART® RPTφ10

SMART® RPZφ10

SMART® RPFφ10

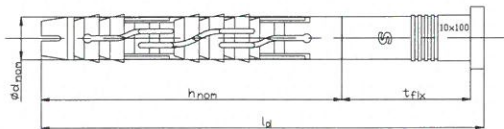

SMART® RPCφ10

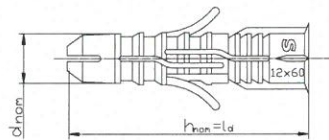

SMART® BPφ12

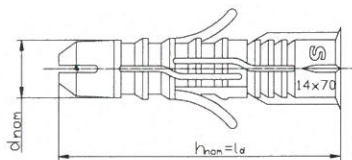

SMART® BPφ14

**SMART® LBP and SMART® BP multifunctional anchors
SMART® RP, RPT, RPZ, RPF and RPC frame anchors**

Product description
Plastic sleeves

Annex A4
of European
Technical Assessment
ETA-10/0392

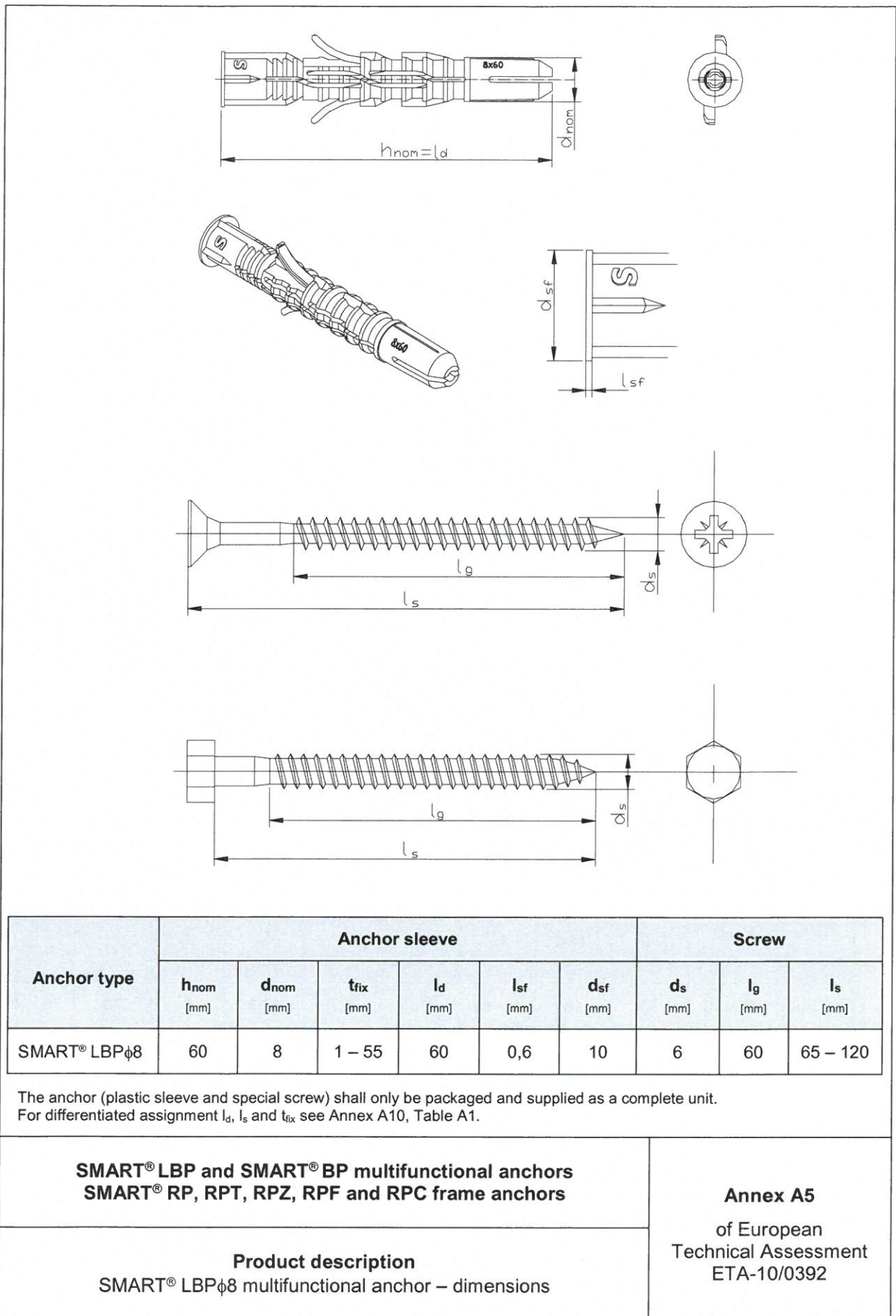

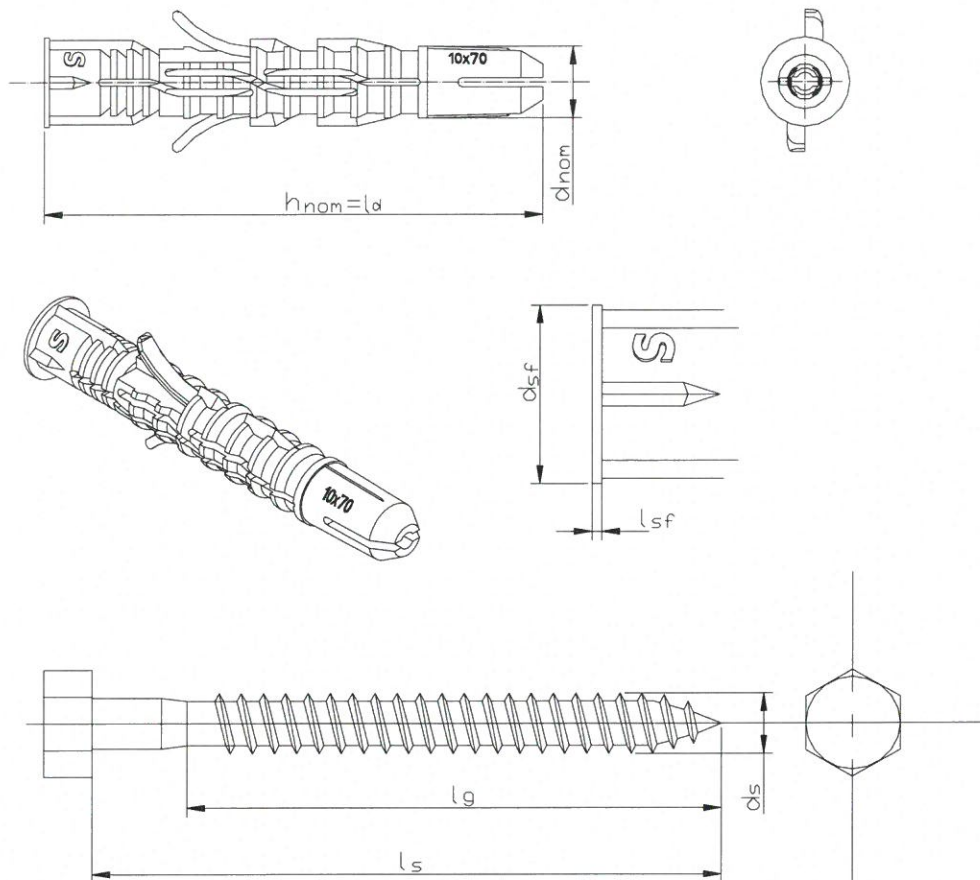

Anchor type	Anchor sleeve						Screw		
	h_{nom} [mm]	d_{nom} [mm]	t_{fix} [mm]	l_d [mm]	l_{sf} [mm]	d_{sf} [mm]	d_s [mm]	l_g [mm]	l_s [mm]
SMART® LBP ϕ 10	70	10	1 – 85	70	0,7	12,5	8	70	75 – 160

The anchor (plastic sleeve and special screw) shall only be packaged and supplied as a complete unit.
For differentiated assignment l_d , l_s and t_{fix} see Annex A10, Table A1.

**SMART® LBP and SMART® BP multifunctional anchors
SMART® RP, RPT, RPZ, RPF and RPC frame anchors**

Product description
SMART® LBP ϕ 10 multifunctional anchor – dimensions

Annex A6
of European
Technical Assessment
ETA-10/0392

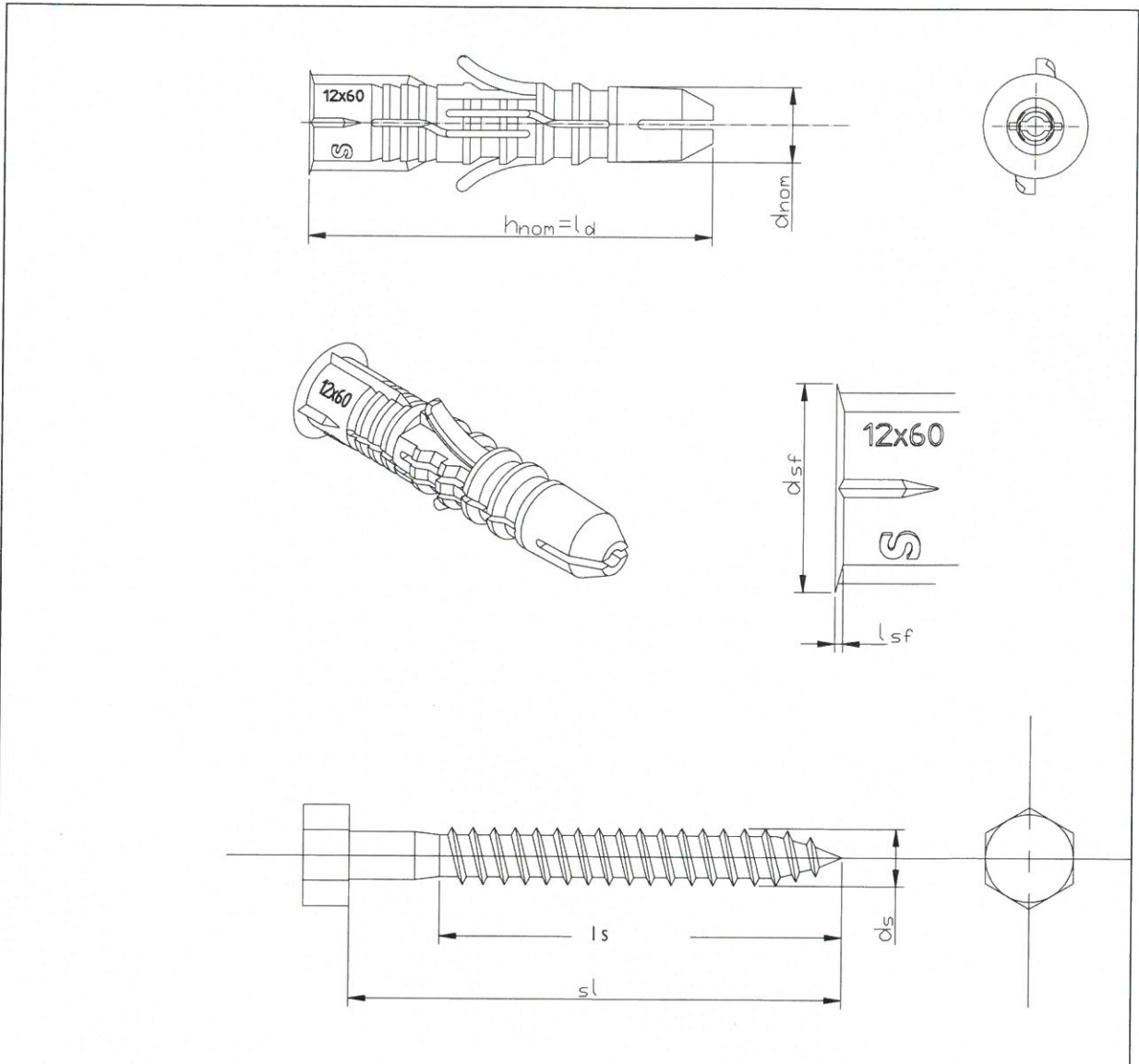

Anchor type	Anchor sleeve						Screw		
	h_{nom} [mm]	d_{nom} [mm]	t_{fix} [mm]	l_d [mm]	l_{sf} [mm]	d_{sf} [mm]	d_s [mm]	l_g [mm]	l_s [mm]
SMART® BP ϕ 12	60	12	1 – 95	60	1,3	14,1	8	60	65 – 160

The anchor (plastic sleeve and special screw) shall only be packaged and supplied as a complete unit.
For differentiated assignment l_d , l_s and t_{fix} see Annex A10, Table A1.

<p>SMART® LBP and SMART® BP multifunctional anchors SMART® RP, RPT, RPZ, RPF and RPC frame anchors</p>	<p>Annex A7 of European Technical Assessment ETA-10/0392</p>
<p>Product description SMART® BPϕ12 multifunctional anchor – dimensions</p>	

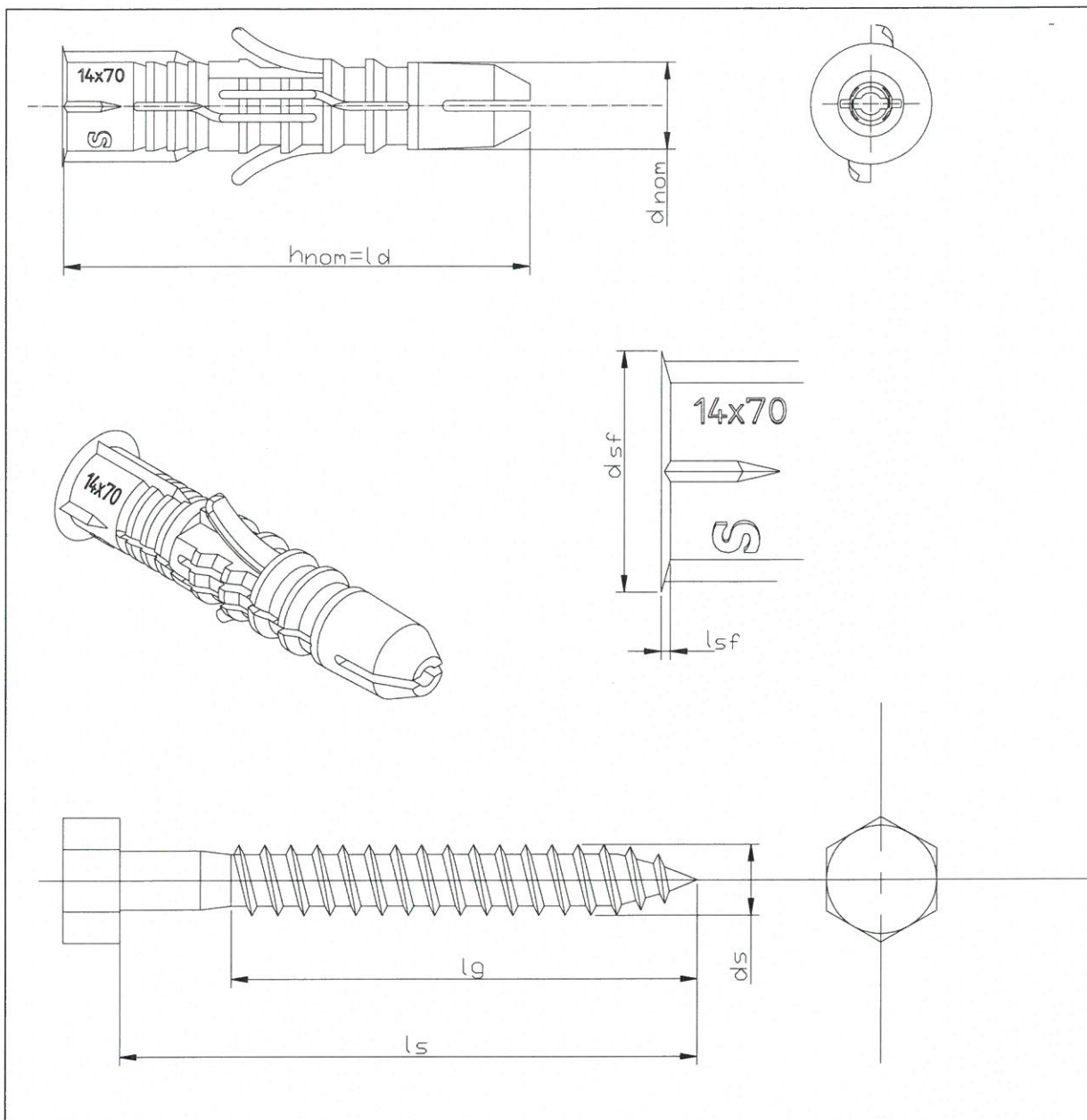

Anchor type	Anchor sleeve						Screw		
	h_{nom} [mm]	d_{nom} [mm]	t_{fix} [mm]	l_d [mm]	l_{sf} [mm]	d_{sf} [mm]	d_s [mm]	l_g [mm]	l_s [mm]
SMART® BP ϕ 14	70	14	1 – 125	70	1,4	16,5	10	70	75 – 200

The anchor (plastic sleeve and special screw) shall only be packaged and supplied as a complete unit.
For differentiated assignment l_d , l_s and t_{fix} see Annex A10, Table A1.

SMART® LBP and SMART® BP multifunctional anchors SMART® RP, RPT, RPZ, RPF and RPC frame anchors	Annex A8 of European Technical Assessment ETA-10/0392
Product description SMART® BP ϕ 14 multifunctional anchor – dimensions	

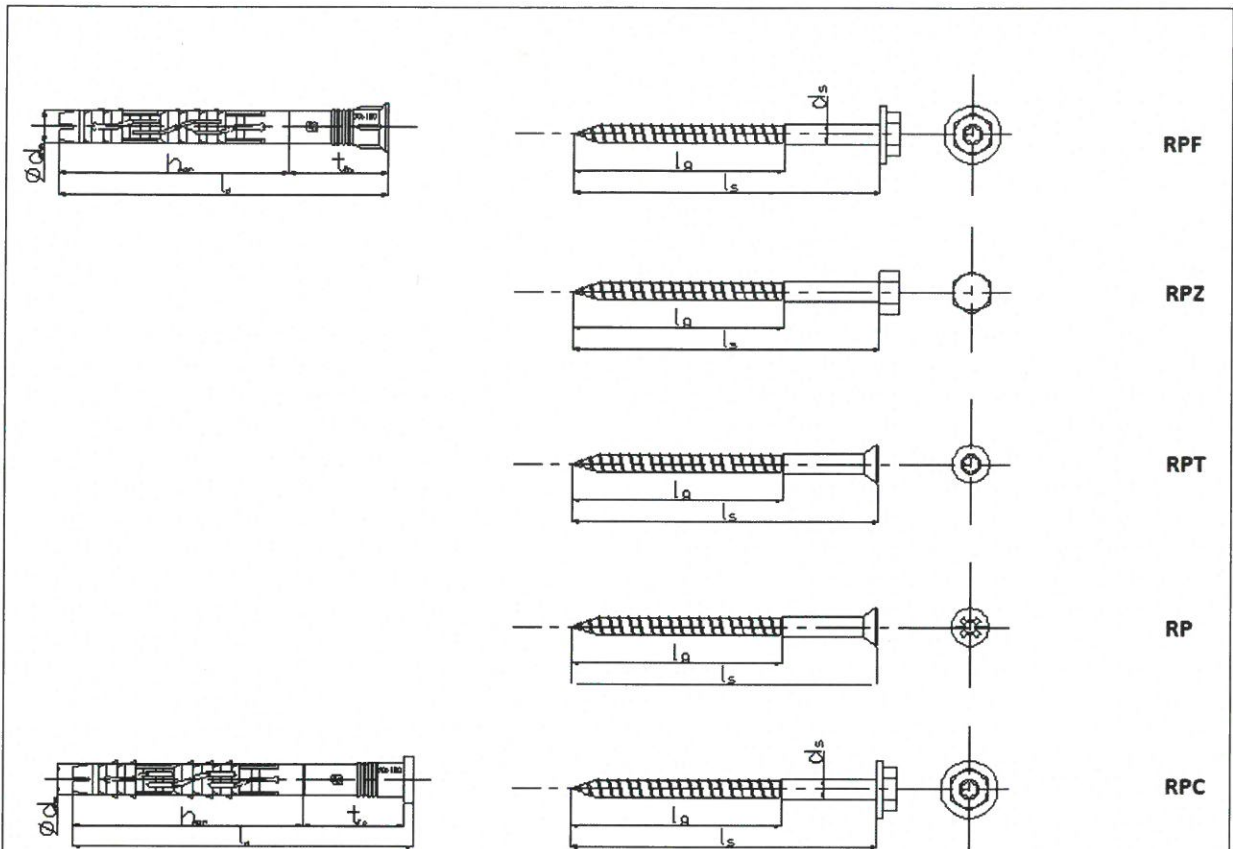

Anchor type	Anchor sleeve				Screw		
	h_{nom} [mm]	d_{nom} [mm]	t_{fix} [mm]	l_d [mm]	d_s [mm]	l_g [mm]	l_s [mm]
SMART® RP SMART® RPT SMART® RPZ SMART® RPF SMART® RPC	70	10	10 – 230	80 – 300	7	60	85 – 305

The anchor (plastic sleeve and special screw) shall only be packaged and supplied as a complete unit. For differentiated assignment l_d , l_s and t_{fix} see Annex A10, Table A1.

SMART® LBP and SMART® BP multifunctional anchors SMART® RP, RPT, RPZ, RPF and RPC frame anchors	Annex A9 of European Technical Assessment ETA-10/0392
Product description SMART® RP, RPT, RPZ, RPF (with countersunk plug) and RPC (with collar) frame anchors– dimensions	

Table A1: Anchor types and dimensions [mm]								
Anchor type	Anchor sleeve					Screw		
	h_{nom} [mm]	d_{nom} [mm]	$t_{fix, min}^{1)}$ [mm]	$t_{fix, max}^{1)}$ [mm]	$l_d^{1)}$ [mm]	d_s [mm]	l_g [mm]	$l_s^{1)}$ [mm]
SMART® LBP ϕ 8	60	8	> 0	1	60	6	60	65
			1	5				70
			5	15				80
			15	25				90
			20	35				100
			40	55				120
SMART® LBP ϕ 10	70	10	> 0	1	70	8	70	75
			1	5				80
			5	15				90
			10	25				100
			30	45				120
			45	65				140
SMART® BP ϕ 12	60	12	> 0	1	60	8	60	65
			1	5				70
			5	15				80
			15	25				90
			20	35				100
			35	55				120
SMART® BP ϕ 14	70	14	> 0	1	70	10	70	75
			1	5				80
			15	25				100
			20	45				120
			45	65				140
			65	85				160
SMART® RP ϕ 10 SMART® RPT ϕ 10 SMART® RPZ ϕ 10 SMART® RPF ϕ 10 SMART® RPC ϕ 10	70	10	–	10 ²⁾	80	7	60	85
			–	30 ²⁾	100			105
			–	50 ²⁾	120			125
			–	70 ²⁾	140			145
			–	90 ²⁾	160			165
			–	110 ²⁾	180			185
–	130 ²⁾	200	205					
–	160 ²⁾	230	235					
–	190 ²⁾	260	265					
–	230 ²⁾	300	305					

¹⁾ The anchor (plastic sleeve and special screw) shall only be packaged and supplied as a complete unit.
²⁾ For SMART® frame anchors only one parameter t_{fix} is used.

SMART® LBP and SMART® BP multifunctional anchors SMART® RP, RPT, RPZ, RPF and RPC frame anchors	Annex A10 of European Technical Assessment ETA-10/0392
Product description Anchor types and dimensions	

Table A2: Materials

Element	Material
Anchor sleeve	Polyamid, PA6, grey colour
Special screw	Steel ($f_{y,k} \geq 450$ MPa, $f_{u,k} \geq 580$ MPa) galvanized $\geq 5 \mu\text{m}$ according to EN ISO 4042 or hot dip galvanized $\geq 25 \mu\text{m}$ according to EN ISO 1461 or stainless steel ($f_{y,k} \geq 600$ MPa, $f_{u,k} \geq 800$ MPa)

**SMART® LBP and SMART® BP multifunctional anchors
SMART® RP, RPT, RPZ, RPF and RPC frame anchors**

Product description
Materials

Annex A11
of European
Technical Assessment
ETA-10/0392

Specification of intended use	
<p>Anchorage subject to:</p> <ul style="list-style-type: none"> ▪ Static and quasi-static loads. ▪ Multiple fixing of non-structural applications. <p>Base materials:</p> <ul style="list-style-type: none"> ▪ Reinforced or unreinforced normal weight concrete with strength classes \geq C12/15 (use category a), according to EN 206. ▪ Solid brick masonry (use category b), according to Annex C3. Note: The characteristic resistance is also valid for larger brick sizes and larger compressive strength of the masonry unit. ▪ Hollow brick masonry (use category c), according to Annex C3. ▪ Autoclaved aerated concrete (use category d), according to Annex C3. ▪ Mortar strength class of the masonry M2.5 at minimum according to EN 998-2. ▪ For other base materials of the use categories a, b, c and d the characteristic resistance of the anchor may be determined by job site tests according to ETAG 020, edition March 2012, Annex B. <p>Temperature range:</p> <ul style="list-style-type: none"> • For anchor types SMART® LBP and SMART® BP: -20°C to +40°C (max. short term temperature +40°C and max. long term temperature +24°C). • For anchor types SMART® RP, SMART® RPT, SMART® RPZ, SMART® RPF and SMART® RPC anchored in concrete: -40°C to +40°C (max. short term temperature +40°C and max. long term temperature +24°C). -40°C to +80°C (max. short term temperature +80°C and max. long term temperature +50°C). • For anchor types SMART® RP, SMART® RPT, SMART® RPZ, SMART® RPF and SMART® RPC anchored in aerated concrete: -40°C to +40°C (max. short term temperature +40°C and max. long term temperature +24°C). <p>Use conditions (environmental conditions):</p> <ul style="list-style-type: none"> ▪ Structures subject to dry internal conditions (zinc coated steel, stainless steel). ▪ Structures subject to external atmospheric exposure including industrial and marine environment (stainless steel). ▪ Structures subject to permanently damp internal condition, if no particular aggressive conditions exist (stainless steel). <p>Note: Particular aggressive conditions are e.g. permanent, alternating immersion in seawater or the splash zone of seawater, chloride atmosphere of indoor swimming pools or atmosphere with extreme chemical pollution (e.g. in desulphurization plants or road tunnels where de-icing materials are used).</p> <p>Design:</p> <ul style="list-style-type: none"> ▪ The anchorages are designed in accordance with the ETAG 020, edition March 2012, Annex C, under the responsibility of an engineer experienced in anchorages and masonry work. ▪ Verifiable calculation notes and drawings shall be prepared taking account the loads to be anchored, the nature and strength of the base materials and the dimensions of the anchorage members as well as of the relevant tolerances. The position of the anchor is indicated on the design drawings. ▪ Fasteners are only to be used for multiple fixings for non-structural application, according to ETAG 020, edition March 2012. <p>Installation:</p> <ul style="list-style-type: none"> ▪ Hole shall be drilled by the drill modes given in Annex C3 for use categories a, b, c and d; the influence of other drilling methods may be determined by job side tests according to ETAG 020, edition March 2012, Annex B. ▪ Anchor installation shall be carried out by appropriately qualified personnel and under the supervision of the person responsible for technical matters of the site. ▪ Installation shall be executed in temperature from 0°C to +20°C for multifunctional anchors and from -40°C to +40°C for frame anchors. ▪ Exposure to UV due to solar radiation of the anchor not protected by the mortar shall not exceed \leq 6 weeks. 	
<p>SMART® LBP and SMART® BP multifunctional anchors SMART® RP, RPT, RPZ, RPF and RPC frame anchors</p>	<p>Annex B1 of European Technical Assessment ETA-10/0392</p>
<p>Intended use Specifications</p>	

Table B1: Installation parameters

Anchor type		LBP ϕ 8	LBP ϕ 10	BP ϕ 12	BP ϕ 14	RP ϕ 10 RPT ϕ 10 RPZ ϕ 10 RPF ϕ 10 RPC ϕ 10
Drill hole diameter	d_o [mm]	8	10	12	14	10
Cutting diameter of drill bit	$d_{cut} \leq$ [mm]	8,45	10,45	12,45	14,5	10,45
Depth of drill hole to deepest point ¹⁾	$h_1 \geq$ [mm]	70	80	70	80	80
Overall plastic anchor embedment depth in the base material ^{1), 2)}	$h_{nom} \geq$ [mm]	60	70	60	70	70
Screw length in the base material ¹⁾	$e \geq$ [mm]	65	75	65	75	75
Diameter of clearance hole in the fixture	$d_f \leq$ [mm]	6 – 6,5	8 – 8,5	10 – 10,5	10 – 10,5	10 – 10,5

¹⁾ See Annexes A1, A2 and A3.

²⁾ For perforated masonry the influence of $h_{nom} \geq 60$ mm (SMART[®] LBP ϕ 8) or $h_{nom} \geq 70$ mm (SMART[®] LBP ϕ 10, SMART[®] RP ϕ 10, SMART[®] RPT ϕ 10, SMART[®] RPZ ϕ 10, SMART[®] RPF ϕ 10 and SMART[®] RPC ϕ 10) has to be detected by job site tests.

**SMART[®] LBP and SMART[®] BP multifunctional anchors
SMART[®] RP, RPT, RPZ, RPF and RPC frame anchors**

Intended use
Installation parameters

Annex B2
of European
Technical Assessment
ETA-10/0392

Table B2: Minimum thickness of member, edge distance and anchor spacing in concrete

Anchor type	Base material	h_{min} [mm]	$C_{cr, N}$ [mm]	C_{min} [mm]	S_{min} [mm]
SMART® LBP ϕ 8	Concrete \geq C16/20 Concrete C12/15	100	100	60	120
			140	140	120
SMART® LBP ϕ 10	Concrete \geq C16/20 Concrete C12/15	100	100	60	100
			140	85	140
SMART® BP ϕ 12	Concrete \geq C16/20 Concrete C12/15	100	100	60	100
			140	85	140
SMART® BP ϕ 14	Concrete \geq C16/20 Concrete C12/15	100	100	60	100
			140	85	140
SMART® RP ϕ 10 SMART® RPT ϕ 10 SMART® RPZ ϕ 10 SMART® RPF ϕ 10 SMART® RPC ϕ 10	Concrete \geq C16/20 Concrete C12/15	100	100	100	80
140			140	112	

Scheme of distances and spacing in concrete

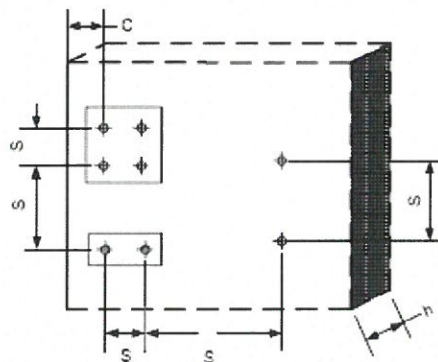

**SMART® LBP and SMART® BP multifunctional anchors
SMART® RP, RPT, RPZ, RPF and RPC frame anchors**

Intended use
Minimum thickness of member, edge
distance and anchor spacing in concrete

Annex B3
of European
Technical Assessment
ETA-10/0392

Table B3: Minimum thickness of member, edge distance and anchor spacing in masonry

Anchor type	Base material ¹⁾	Single anchor			Anchor group	
		h_{min} [kN]	C_{min} [mm]	S_{min} [mm]	$S_{min1}^{2)}$ [kN]	$S_{min2}^{3)}$ [mm]
SMART® LBP ϕ 8	Clay brick	120	100	250	> 200	> 400
	Vertically perforated clay brick	250				
SMART® LBP ϕ 10	Clay brick	120	100	250	> 200	> 400
	Vertically perforated clay brick	250				
SMART® BP ϕ 12	Clay brick	120	100	250	> 200	> 400
SMART® BP ϕ 14	Clay brick	120	100	250	> 200	> 400
SMART® RP ϕ 10 SMART® RPT ϕ 10 SMART® RPZ ϕ 10 SMART® RPF ϕ 10 SMART® RPC ϕ 10	Clay brick	115	120	250	> 240	> 480
	Vertically perforated elements	115	120	250	> 240	> 480
	AAC	100	80	250	> 200	> 400

1) Information for base material masonry: see Table C5
 2) In direction perpendicular to free edge
 3) In direction parallel to free edge

Scheme of distances and spacing in masonry

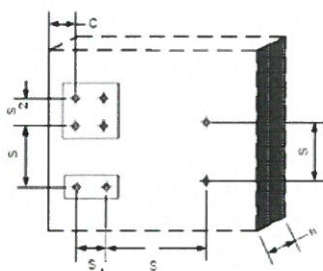

**SMART® LBP and SMART® BP multifunctional anchors
 SMART® RP, RPT, RPZ, RPF and RPC frame anchors**

Intended use
 Minimum thickness of member, edge distance and anchor spacing in masonry

Annex B4
 of European
 Technical Assessment
 ETA-10/0392

<p>a)</p> 	<p>a) Drill the hole considering the drilling method and clean the hole of drilling dust</p>	
<p>b)</p> 	<p>b) Insert the plastic sleeve and special screw into the hole through the fixture by slight hammer blows</p>	
<p>c)</p> 	<p>c), d), e) Screw-in the special screw until the head of the screw touches the sleeve; the anchor is correct mounted, if there is no turn-through of the plastic sleeve in the drill hole and if slightly move on turning of the screw is impossible.</p>	
<p>d)</p> 		
<p>e)</p> 		
<p>SMART® LBP and SMART® BP multifunctional anchors SMART® RP, RPT, RPZ, RPF and RPC frame anchors</p>		<p>Annex B5 of European Technical Assessment ETA-10/0392</p>
<p>Intended use Installation instruction</p>		

Table C1: Characteristic bending resistance of the screw

Anchor type		LBPφ8	LBPφ10	BPφ12	BPφ14	RPφ10 RPTφ10 RPZφ10 RPFφ10 RPCφ10
Characteristic bending resistance	$M_{Rk,s}$ [Nm]	11,35 ¹⁾	28,69 ¹⁾	28,69 ¹⁾	57,59 ¹⁾	22,62 ¹⁾
		15,66 ²⁾	39,59 ²⁾	39,59 ²⁾	79,47 ²⁾	31,22 ²⁾
Partial safety factor	γ_{Ms} ³⁾	1,28	1,28	1,28	1,28	1,28
¹⁾ galvanized steel ²⁾ stainless steel ³⁾ in absence of other national regulations						

Table C2: Characteristic resistance of the screw

Anchor type (shortening)		LBPφ8	LBPφ10	BPφ12	BPφ14	RPφ10 RPTφ10 RPZφ10 RPFφ10 RPCφ10
Characteristic tension resistance	$N_{Rk,s}$ [kN]	7,25 ¹⁾	13,74 ¹⁾	13,74 ¹⁾	22,97 ¹⁾	16,35 ¹⁾
		10,01 ²⁾	18,96 ²⁾	18,9 ²⁾	31,70 ²⁾	22,56 ²⁾
Partial safety factor	γ_{Ms} ³⁾	1,54	1,54	1,54	1,55	1,54
Characteristic shear resistance	$V_{Rk,s}$ [kN]	3,28 ¹⁾	6,98 ¹⁾	6,98 ¹⁾	13,16 ¹⁾	11,08 ¹⁾
		4,53 ²⁾	9,63 ²⁾	9,63 ²⁾	18,16 ²⁾	15,29 ²⁾
Partial safety factor	γ_{Ms} ³⁾	1,28	1,28	1,28	1,28	1,28
¹⁾ galvanized steel ²⁾ stainless steel ³⁾ in absence of other national regulations						

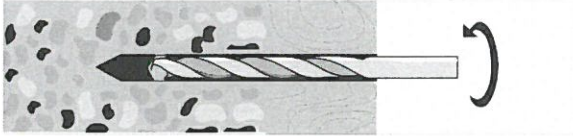
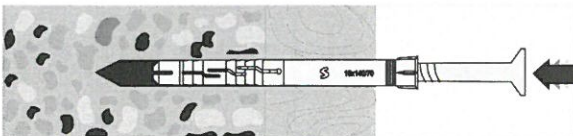
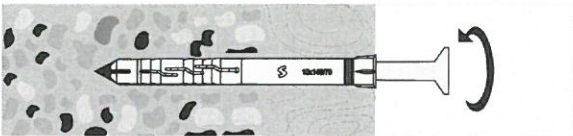
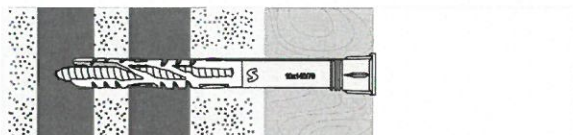
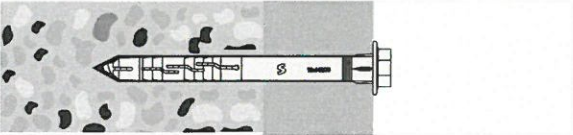
**SMART® LBP and SMART® BP multifunctional anchors
 SMART® RP, RPT, RPZ, RPF and RPC frame anchors**

Performances
 Characteristic resistance of the screw

Annex C1
 of European
 Technical Assessment
 ETA-10/0392

Table C3: Characteristic resistance for use in concrete, pull-out failure (plastic sleeve); hammer drilling

Anchor type		LBP ϕ 8	LBP ϕ 10	BP ϕ 12	BP ϕ 14	RP ϕ 10 RPT ϕ 10 RPZ ϕ 10 RPF ϕ 10 RPC ϕ 10
Temperature range		24/40°C ¹⁾ and 50/80°C ²⁾				
Concrete \geq C16/20						
Characteristic resistance	$N_{Rk,p}$ [kN]	0,9	1,5	1,5	1,5	2,5
Partial safety factor	γ_{Mc} ³⁾	1,8				
Concrete C12/15						
Characteristic resistance	$N_{Rk,p}$ [kN]	0,6	0,9	0,9	0,9	1,5
Partial safety factor	γ_{Mc} ³⁾	1,8				
¹⁾ for all anchor types ²⁾ for anchor type RP ϕ 10, RPT ϕ 10, RPZ ϕ 10, RPF ϕ 10 and RPC ϕ 10 ³⁾ in absence of other national regulations						

Table C4: Displacements under tension and shear loading in concrete







Anchor type	Tension load			Shear load		
	N [kN]	δ_{NO} [mm]	$\delta_{N\infty}$ [mm]	V [kN]	δ_{v0} [mm]	$\delta_{v\infty}$ [mm]
SMART® LBP ϕ 8	0,35	0,32	0,50	0,51	0,23	0,34
SMART® LBP ϕ 10	0,59	0,37	0,66	0,85	0,45	0,67
SMART® BP ϕ 12	0,59	0,71	0,80	0,85	0,38	0,57
SMART® BP ϕ 14	0,59	0,69	0,70	0,85	0,46	0,69
SMART® RP ϕ 10 SMART® RPT ϕ 10 SMART® RPZ ϕ 10 SMART® RPF ϕ 10	1,00	0,65	1,30	1,00	0,83	1,24
SMART® RPC ϕ 10	1,00	0,65	1,00	1,00	0,83	1,24

**SMART®LBP and SMART®BP multifunctional anchors
SMART® RP, RPT, RPZ, RPF and RPC frame anchors**

Performances
Characteristic resistance in concrete (use category a),
displacements in concrete

Annex C2
of European
Technical Assessment
ETA-10/0392

Table C5: Characteristic resistance F_{Rk} [kN] in masonry





Anchor type / Base material	Bulk density class [kg/dm ³]	Compressive strength class [N/mm ²]	Picture	Drill method	$F_{Rk}^{1)}$ [kN]
SMART® LBPϕ8					
Clay brick HD 250 x 120 x 65 EN 771-1	$\geq 1,8$	≥ 20		hammer	0,6 ³⁾
Vertically perforated porositet block Porotherm 25 P+W, EN 771-1	$\geq 0,8$	≥ 15		rotary drilling only	0,5 ³⁾
SMART® LBPϕ10					
Clay brick HD 250 x 120 x 65 EN 771-1	$\geq 1,8$	≥ 20		hammer	1,5 ³⁾
Vertically perforated porositet block Porotherm 25 P+W, EN 771-1	$\geq 0,8$	≥ 15		rotary drilling only	0,3 ³⁾
SMART® BPϕ12					
Clay brick HD 250 x 120 x 65 EN 771-1	$\geq 1,8$	≥ 20		hammer	3,5 ³⁾
SMART® BPϕ14					
Clay brick HD 250 x 120 x 65 EN 771-1	$\geq 1,8$	≥ 20		hammer	3,5 ³⁾

**SMART® LBP and SMART® BP multifunctional anchors
SMART® RP, RPT, RPZ, RPF and RPC frame anchors**

Performances
Characteristic resistance in masonry (use category b, c and d)

Annex C3
of European
Technical Assessment
ETA-10/0392

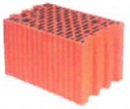
Extension of Table C5

Anchor type / Base material	Bulk density class [kg/dm ³]	Compressive strength class [N/mm ²]	Picture	Drill method	F _{Rk} ¹⁾ [kN]
SMART® RP ϕ 10, SMART® RPT ϕ 10, SMART® RPZ ϕ 10, SMART® RPF ϕ 10 and SMART® RPC ϕ 10					
Clay brick Mz 20 – 2,0, EN 771-1	≥ 2,17	≥ 20		hammer	4,5 ³⁾ (4,0) ⁴⁾
Perforated ceramic brick Hlz, EN 771-1 a ¹⁾ = 12 mm	≥ 1,09	≥ 25		rotary drilling only	1,5 ³⁾ (1,2) ⁴⁾
Vertically perforated porosited block (Porotherm 25 P+W), EN 771-1 a ¹⁾ = 10 mm	≥ 0,75	≥ 15		rotary drilling only	0,9 ³⁾ (0,75) ⁴⁾
Vertical perforated ceramic block (Max 250), EN 771-1 a ¹⁾ = 12 mm	≥ 0,8	≥ 15		rotary drilling only	0,9 ³⁾ . 4)
Autoclaved aerated concrete AAC2	360	≥ 2	–	rotary drilling only	0,5 ³⁾
Autoclaved aerated concrete AAC7	660	≥ 7	–	rotary drilling only	1,5 ³⁾
Partial safety factor ²⁾ γ_{Mm}	2,5				
<p>1) Characteristic resistance F_{Rk} for tension, shear or combined tension and shear loading. The characteristic resistance is valid for single plastic anchor or for a group of two or four plastic anchors with a spacing equal or larger than the minimum spacing s_{min} according to Table B3 (Annex B4).</p> <p>2) In absence of other national regulations.</p> <p>3) Temperature range “a” (+24°C to +40°C).</p> <p>4) Temperature range “b” (+50°C to +80°C).</p>					

SMART® LBP and SMART® BP multifunctional anchors
SMART® RP, RPT, RPZ, RPF and RPC frame anchors

Performances
 Characteristic resistance in masonry (use category b, c and d)

Annex C3
 of European
 Technical Assessment
 ETA-10/0392

Table C6: Displacements under tension and shear loading in clay brick, in vertically perforated clay brick and in autoclaved aerated concrete

Anchor type	Base material ¹⁾	Tension load			Shear load		
		N [kN]	δ_{NO} [mm]	δN_{∞} [mm]	V [kN]	δ_{VO} [mm]	δV_{∞} [mm]
SMART® LBP ϕ 8	Clay brick	0,11	0,13	0,26	0,11	0,09	0,14
	Vertically perforated porous block	0,08	0,13	0,26	0,08	0,06	0,09
SMART® LBP ϕ 10	Clay brick	0,21	0,18	0,36	0,21	0,17	0,26
	Vertically perforated porous block	0,11	1,01	2,02	0,11	0,09	0,14
SMART® BP ϕ 12	Clay brick	0,21	0,32	0,64	0,21	0,17	0,26
SMART® BP ϕ 14	Clay brick	0,25	1,00	2,00	0,25	0,21	0,31
SMART® RP ϕ 10 SMART® RPT ϕ 10 SMART® RPZ ϕ 10 SMART® RPF ϕ 10 SMART® RPC ϕ 10	Clay brick	1,28	1,51	3,02	1,28	1,07	1,60
	Perforated ceramic brick	0,43	0,80	1,60	0,43	0,36	0,54
	Vertically perforated porous block	0,26	0,68	1,36	0,26	0,22	0,33
	Vertically perforated ceramic block	0,26	0,51	1,02	0,26	0,22	0,33
	Autoclaved aerated concrete AAC2	0,17	0,24	0,48	0,17	0,34	0,51
	Autoclaved aerated concrete AAC7	0,53	0,61	1,22	0,53	1,06	1,59
1) Information for base material masonry: see Table C5							

**SMART® LBP and SMART® BP multifunctional anchors
SMART® RP, RPT, RPZ, RPF and RPC frame anchors**

Performances
Displacements in masonry

Annex C4
of European
Technical Assessment
ETA-10/0392

